

TOWN OF LONGMEADOW, MASSACHUSETTS

Plan of 2021 SIDEWALK REPLACEMENT PROJECT

SELECT BOARD
THOMAS LACHIUSA, CHAIR
MARC A. STRANGE, VICE CHAIR
STEVEN M. MARANTZ, CLERK
MARK P. GOLD, MEMBER
RICHARD FOSTER, MEMBER

TOWN MANAGER
LYN N. SIMMONS

DEPARTMENT OF PUBLIC WORKS
MARIO MAZZA, DIRECTOR
TIMOTHY KEANE, PE, LSP, TOWN ENGINEER
CRAIG MARKHAM, ASSISTANT ENGINEER

**Longmeadow
Engineering
Department**

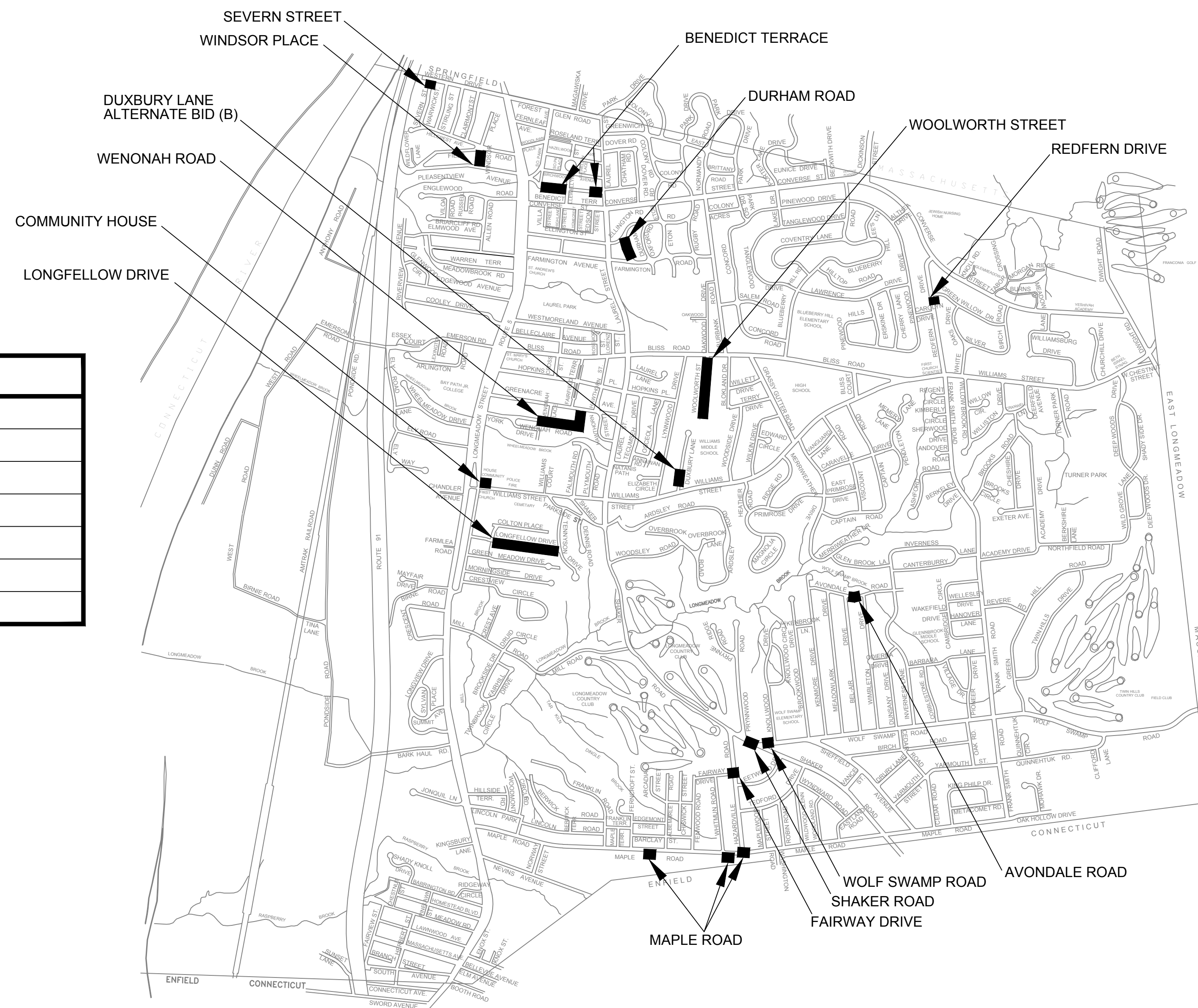
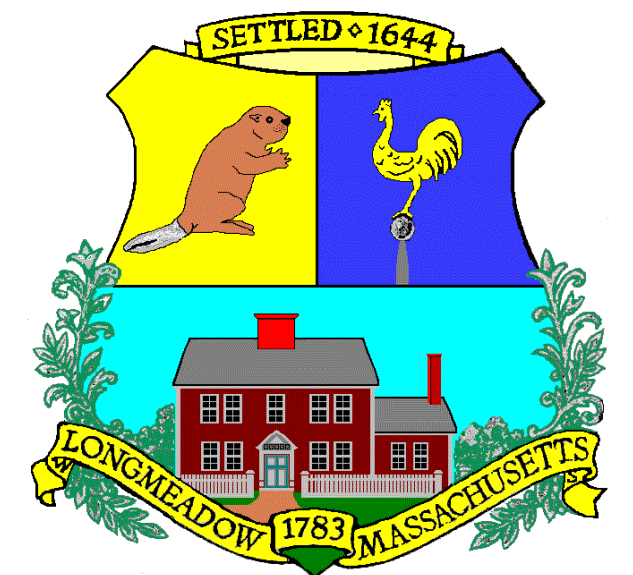

LOCUS MAP
Not To Scale

INDEX

SHEET NUMBER	DESCRIPTION
1	COVER SHEET
2	WOLLWORTH STREET & LONGFELLOW DRIVE
3	WENONAH ROAD & DURHAM ROAD
4	MISCELLANEOUS LOCATIONS
5	CONSTRUCTION DETAILS & SECTIONS

COMPLETE SET 5 SHEETS

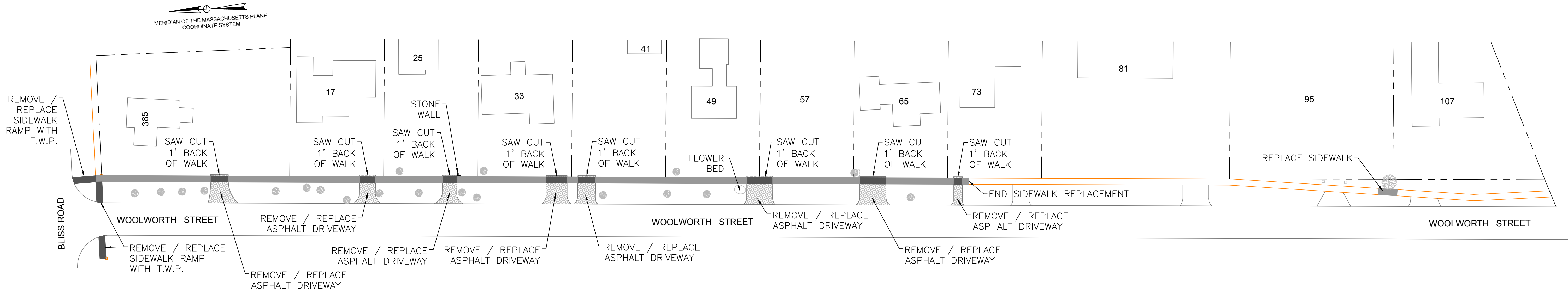

NOTE: NO WORK TO BE PREFORMED ON THIS STREET UNTIL JUNE 23, 2021 (END OF SCHOOL)

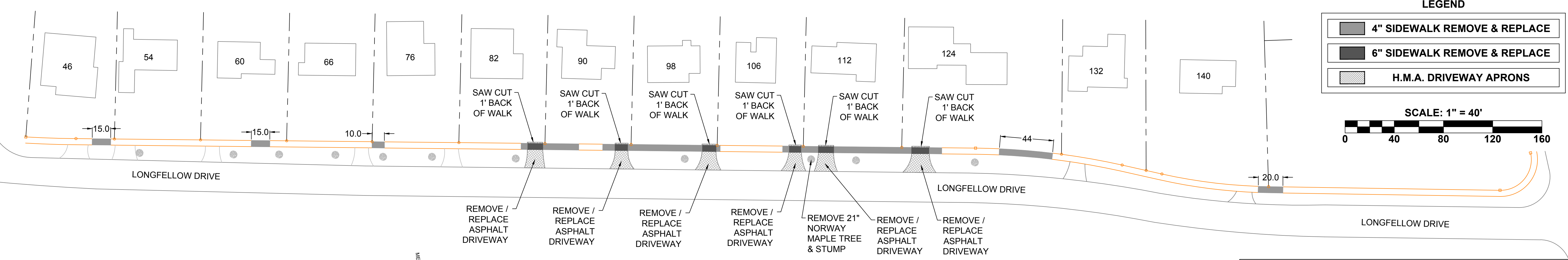

TOWN of LONGMEADOW ENGINEERING DEPARTMENT
2021 SIDEWALK REPLACEMENT PROJECT

Woolworth Street & Longfellow Drive
Sidewalk Replacement
Longmeadow Ma, 01106

DATE: April 2021

2021 Sidewalks Construction Plans.dwg Drawn by: CM Approved by: TK

MERIDIAN OF THE MASSACHUSETTS PLANE
COORDINATE SYSTEM

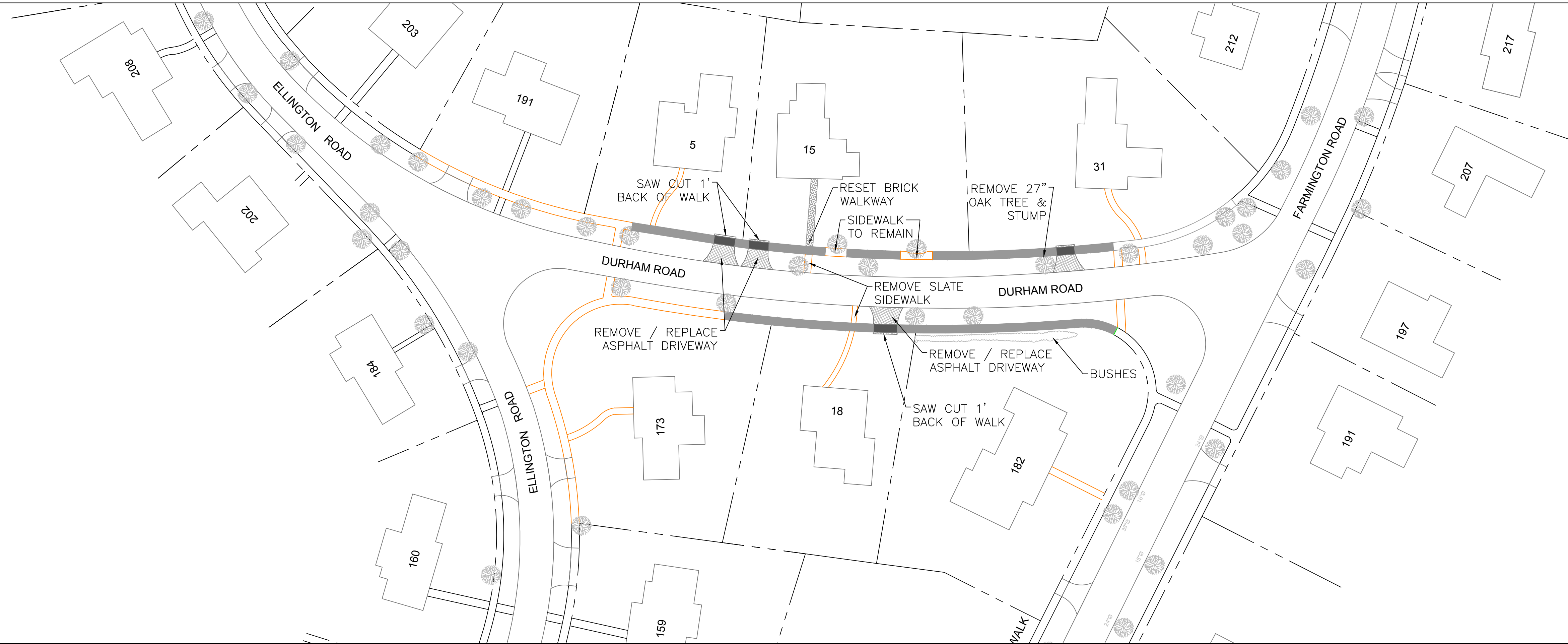
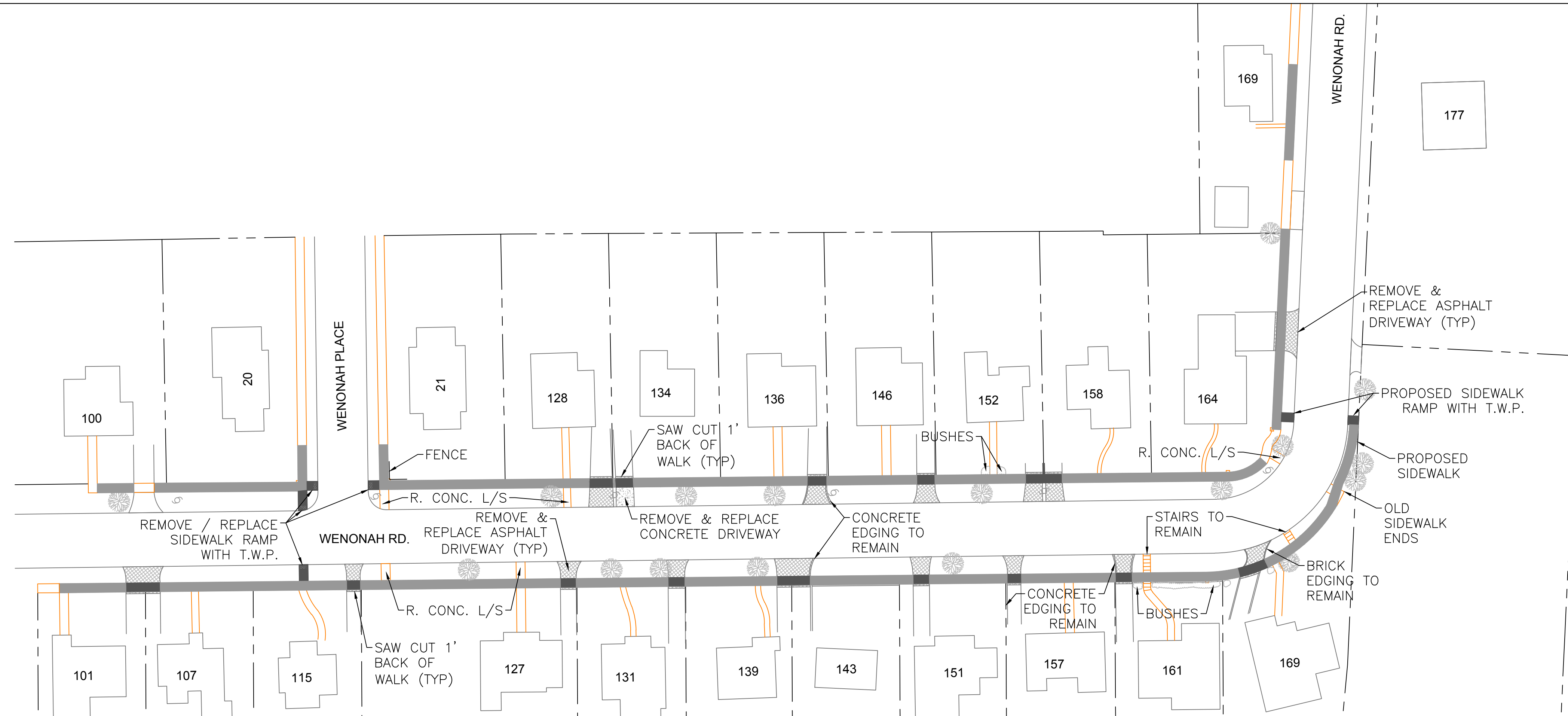

LEGEND

	4" SIDEWALK REMOVE & REPLACE
	6" SIDEWALK REMOVE & REPLACE
	H.M.A. DRIVEWAY APRONS

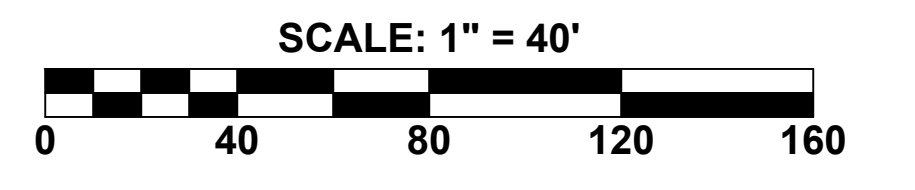

MERIDIAN OF THE MASSACHUSETTS PLANE
COORDINATE SYSTEM

TOWN of LONGMEADOW ENGINEERING DEPARTMENT
2021 SIDEWALK REPLACEMENT PROJECT

**Wenonah Road & Durham Road
Sidewalk Replacement
Longmeadow Ma, 01106**

DATE: April 2021
2021 Sidewalks Construction Plans.dwg Drawn by: CM Approved by: tK

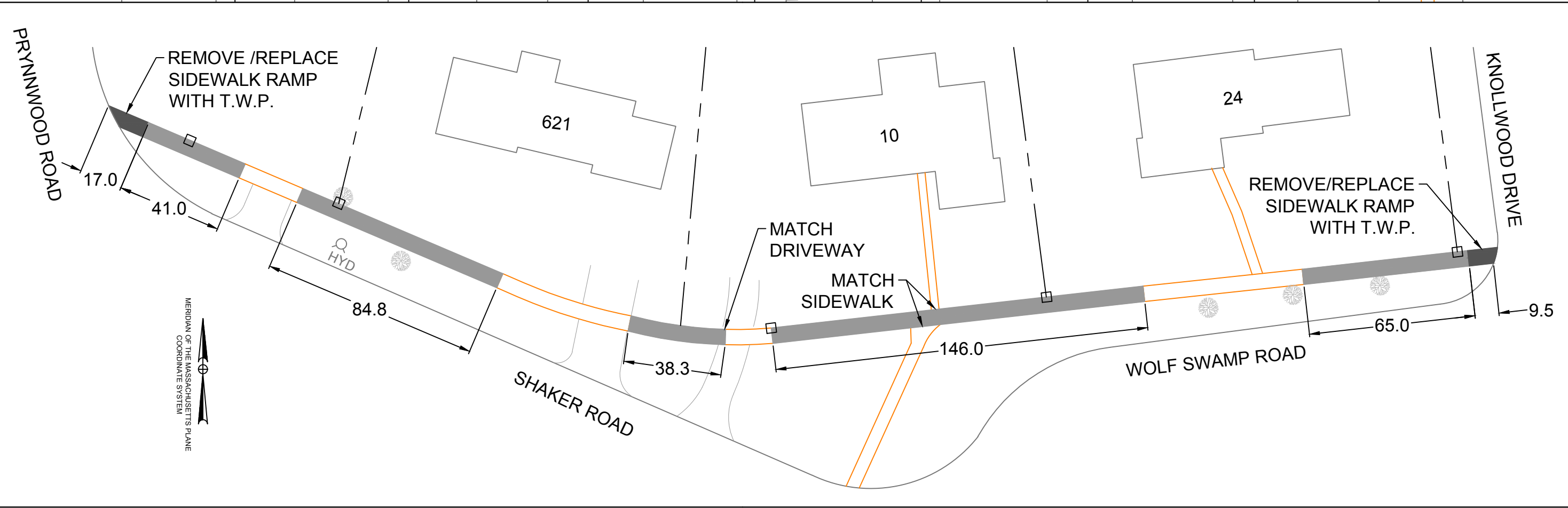
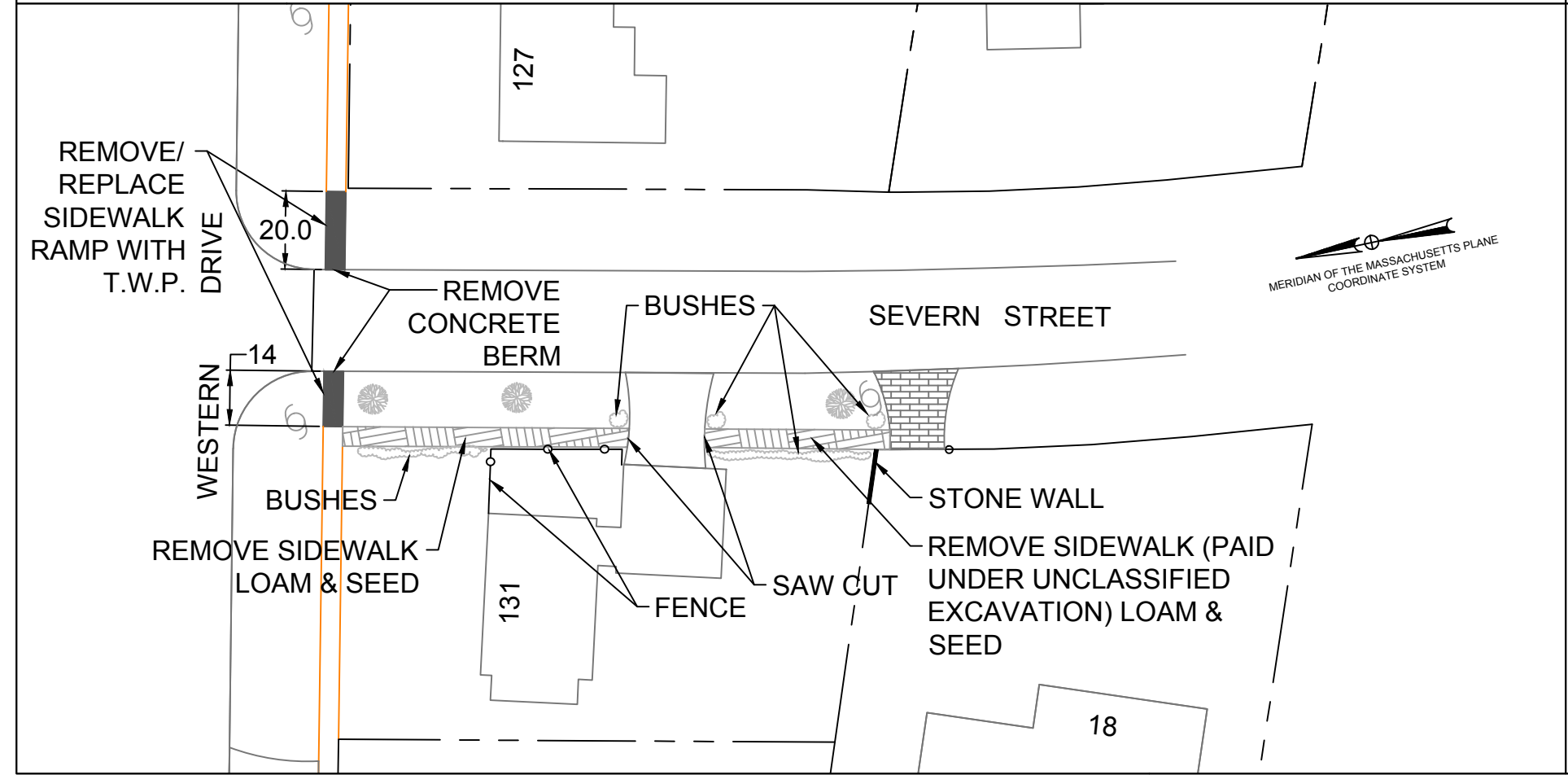
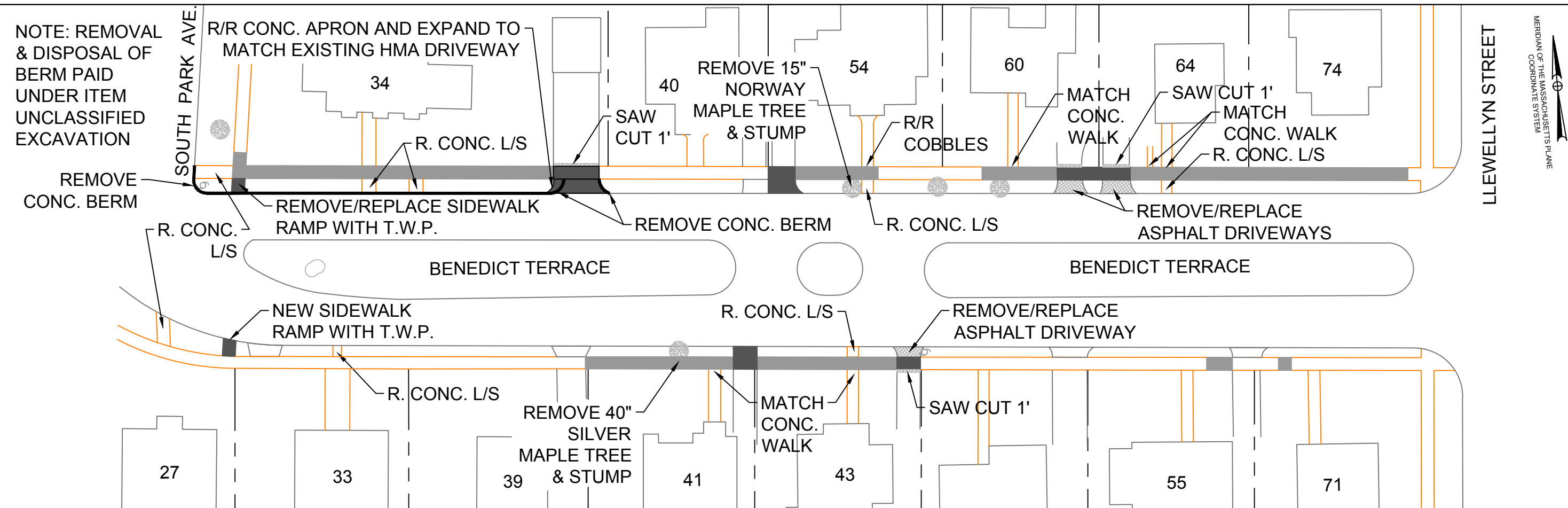
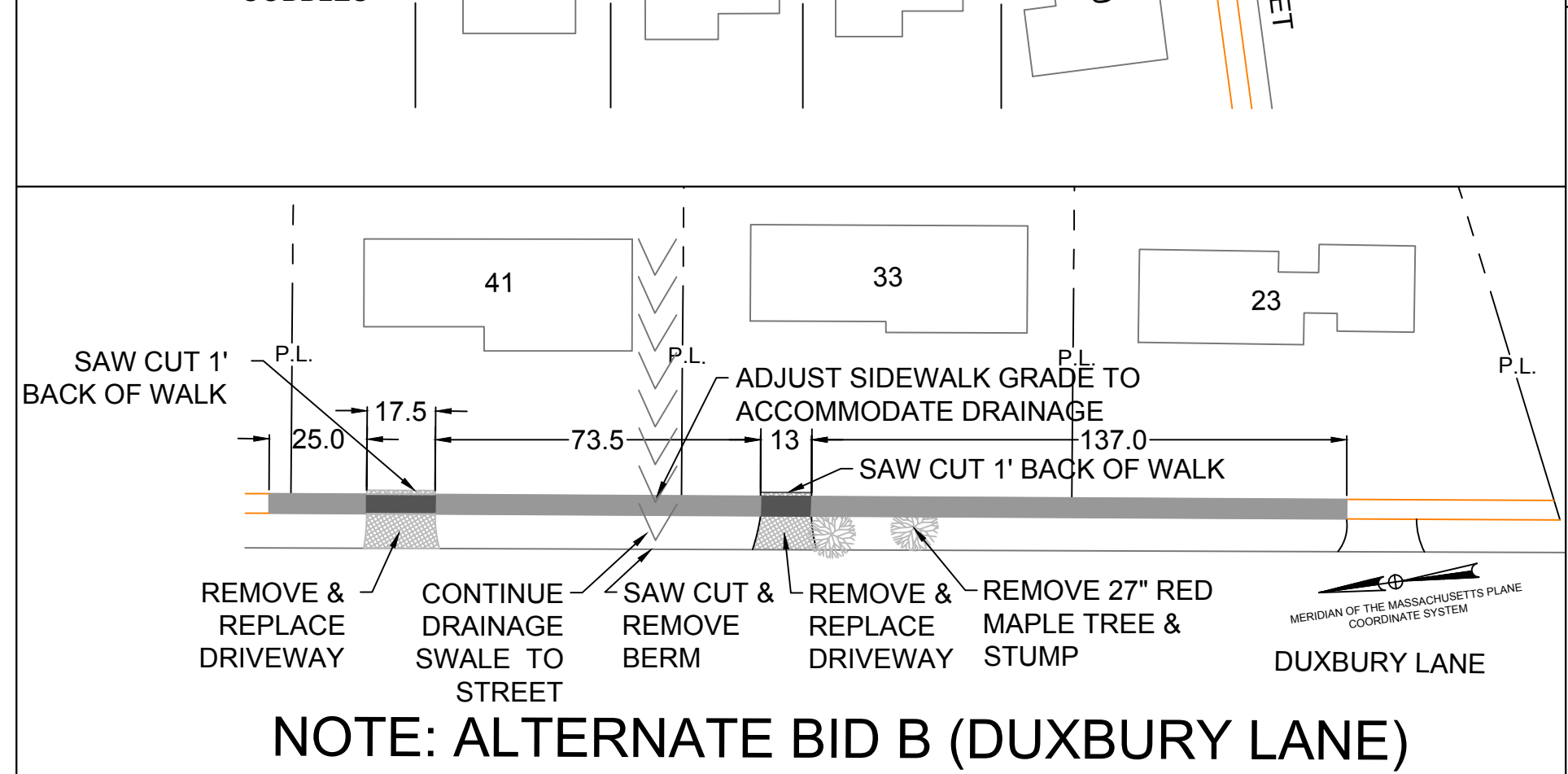
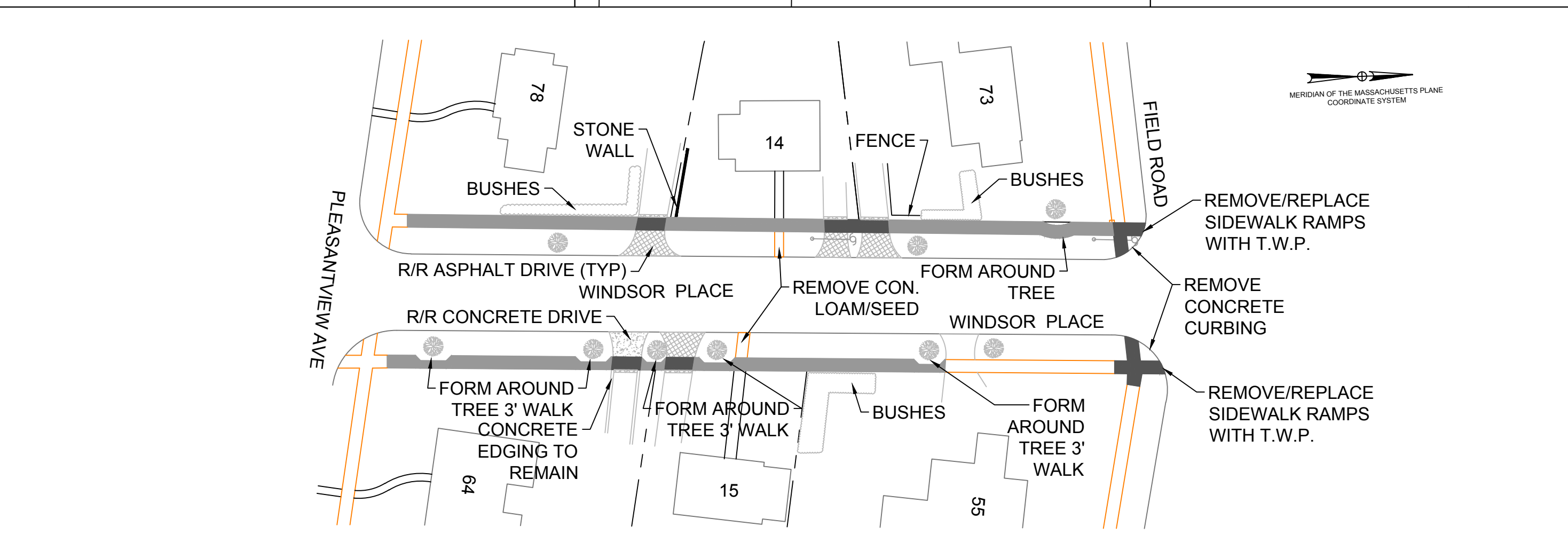
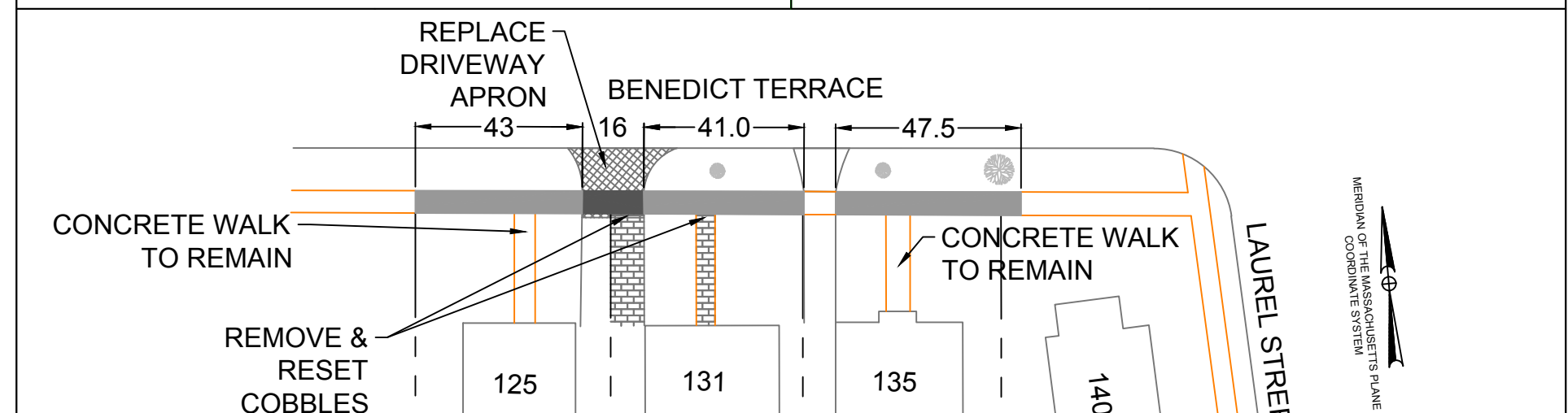
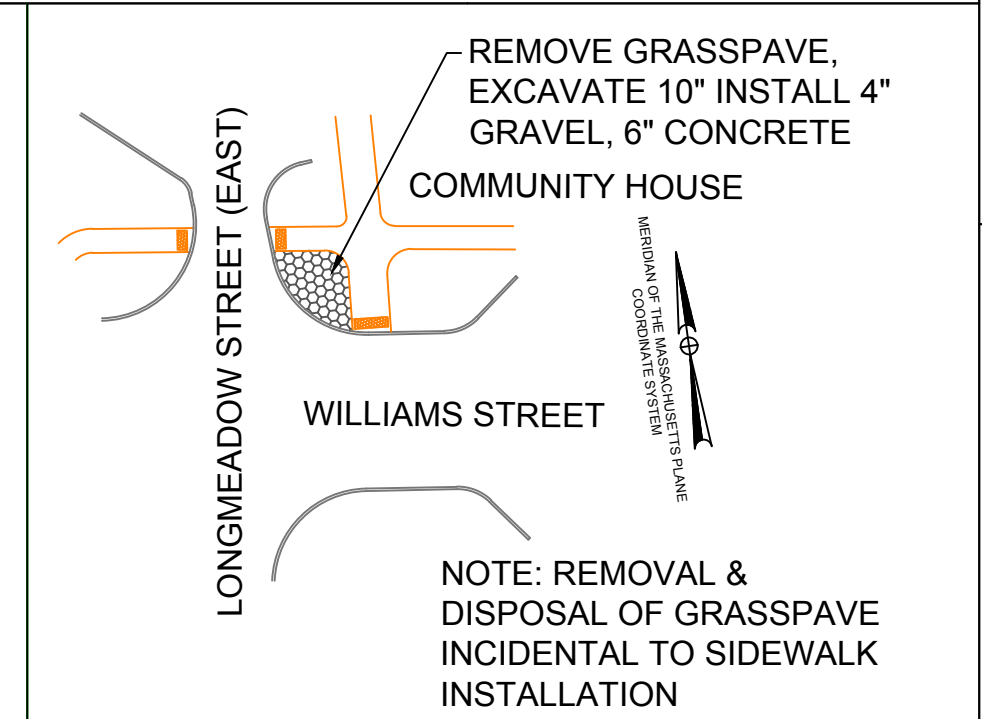
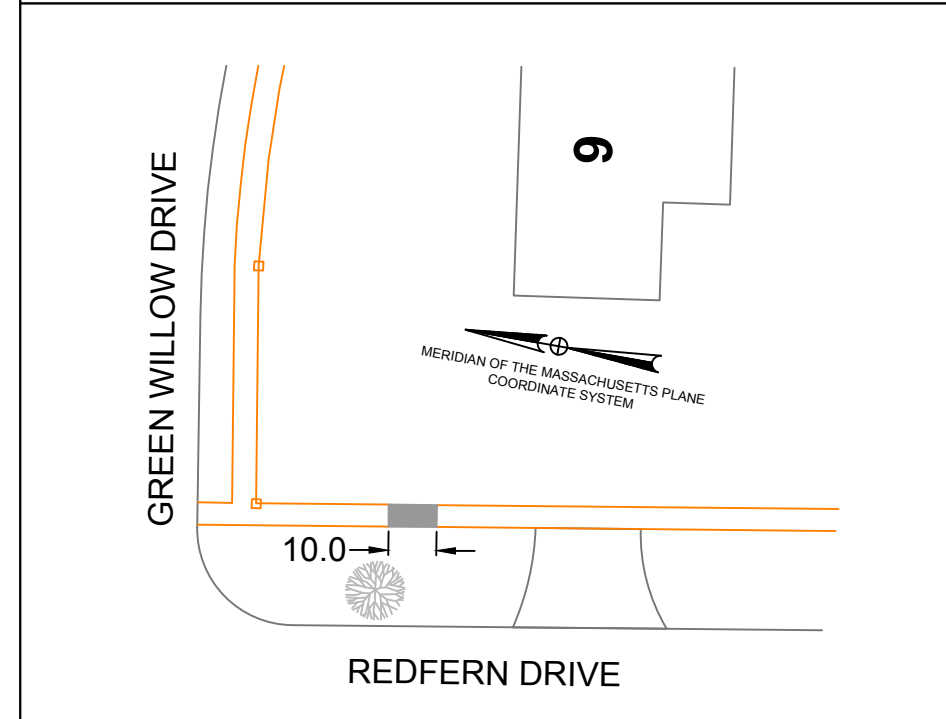
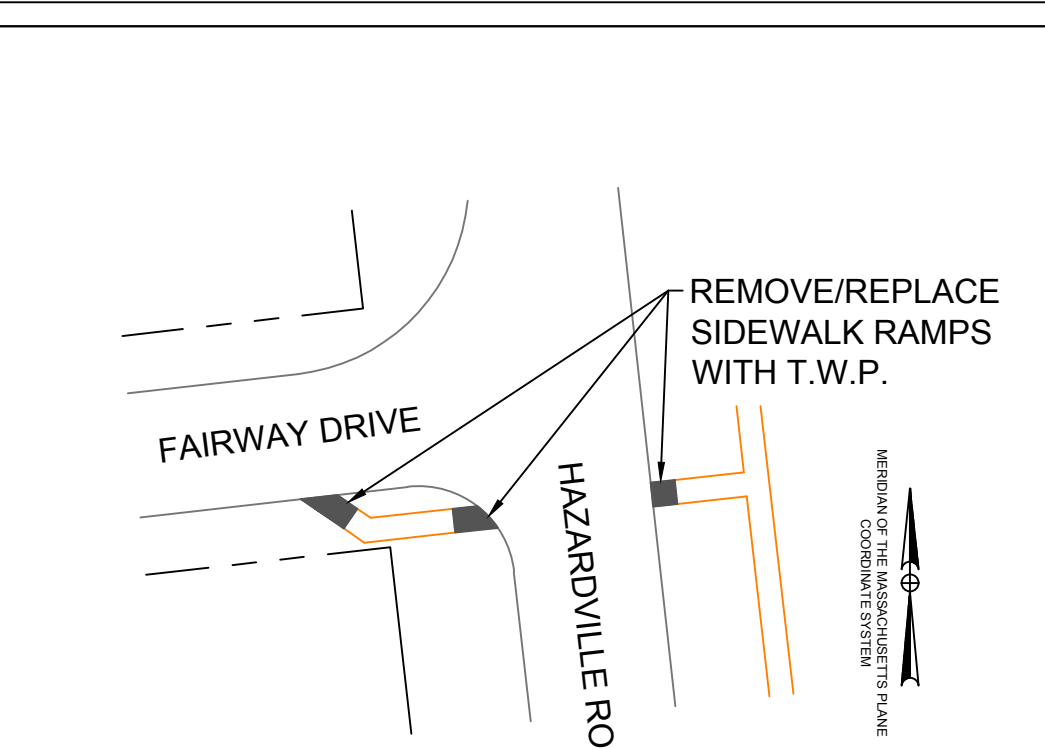
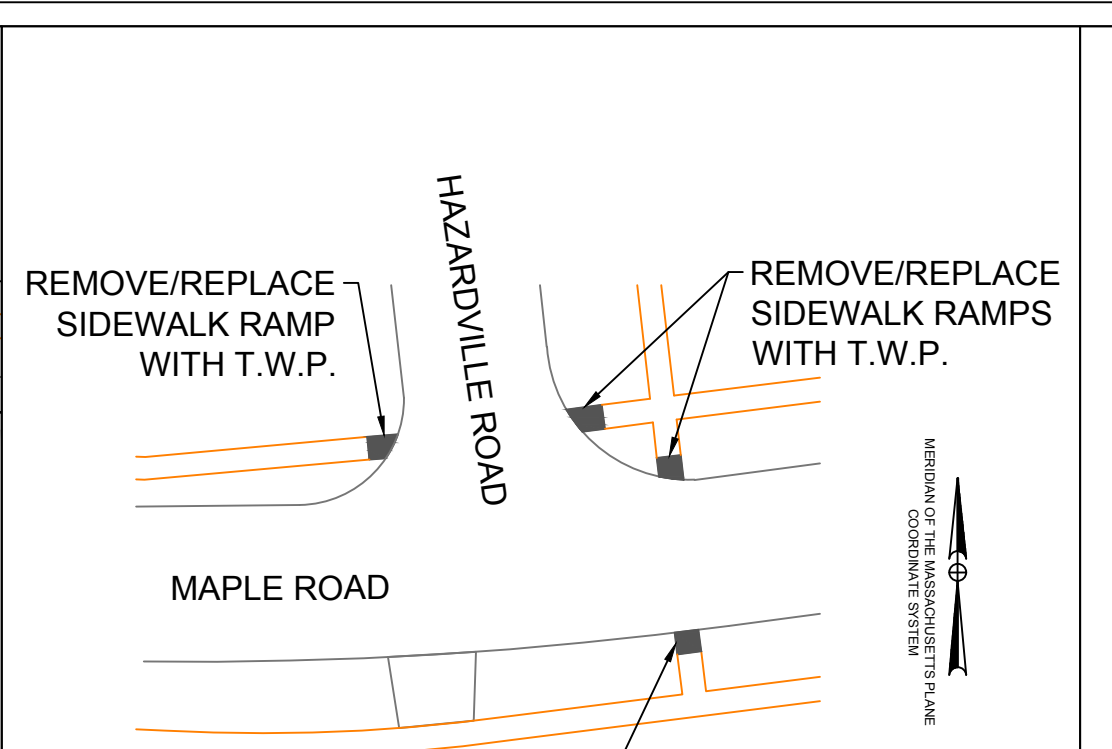
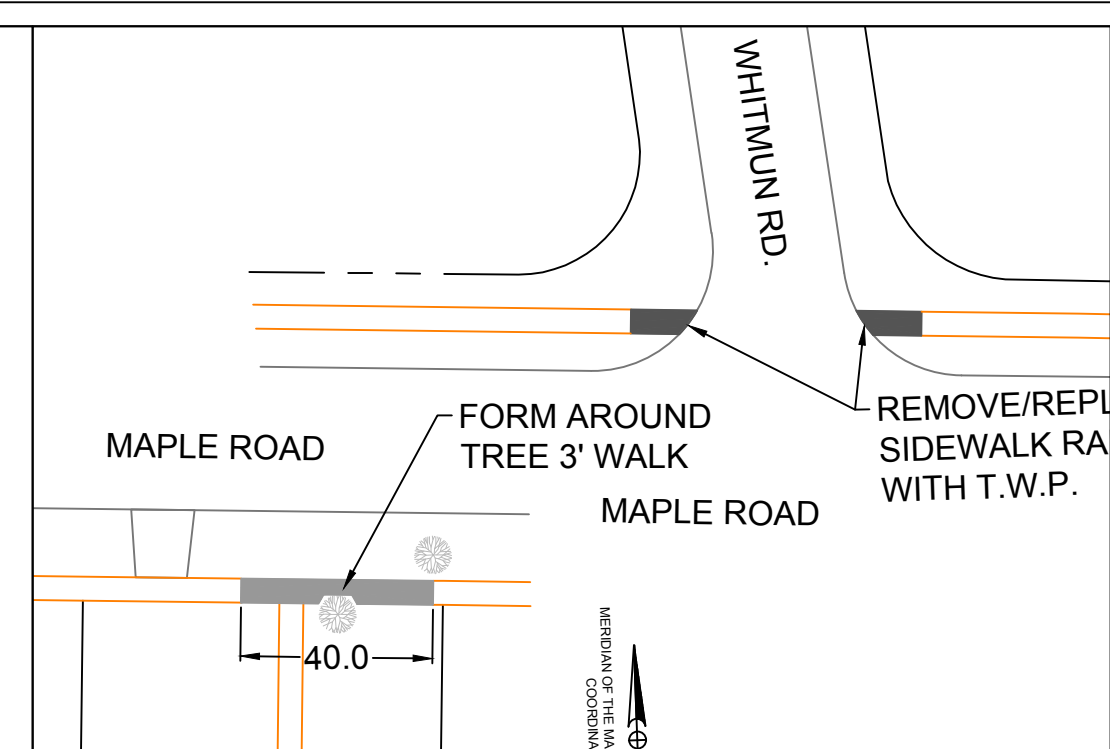
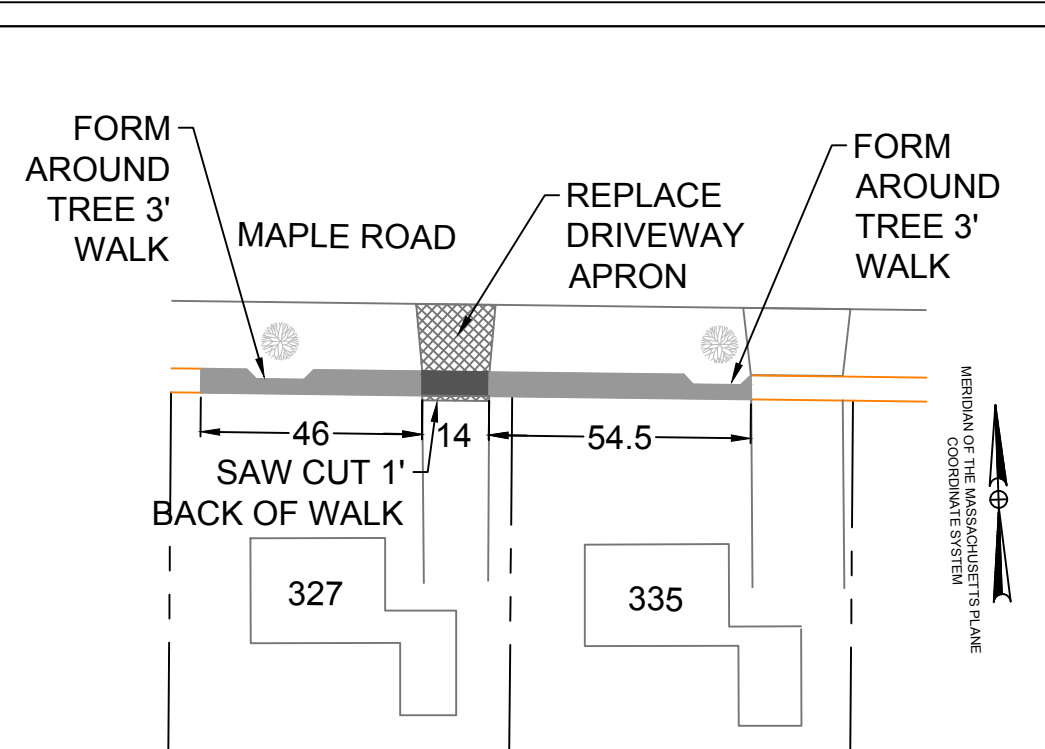
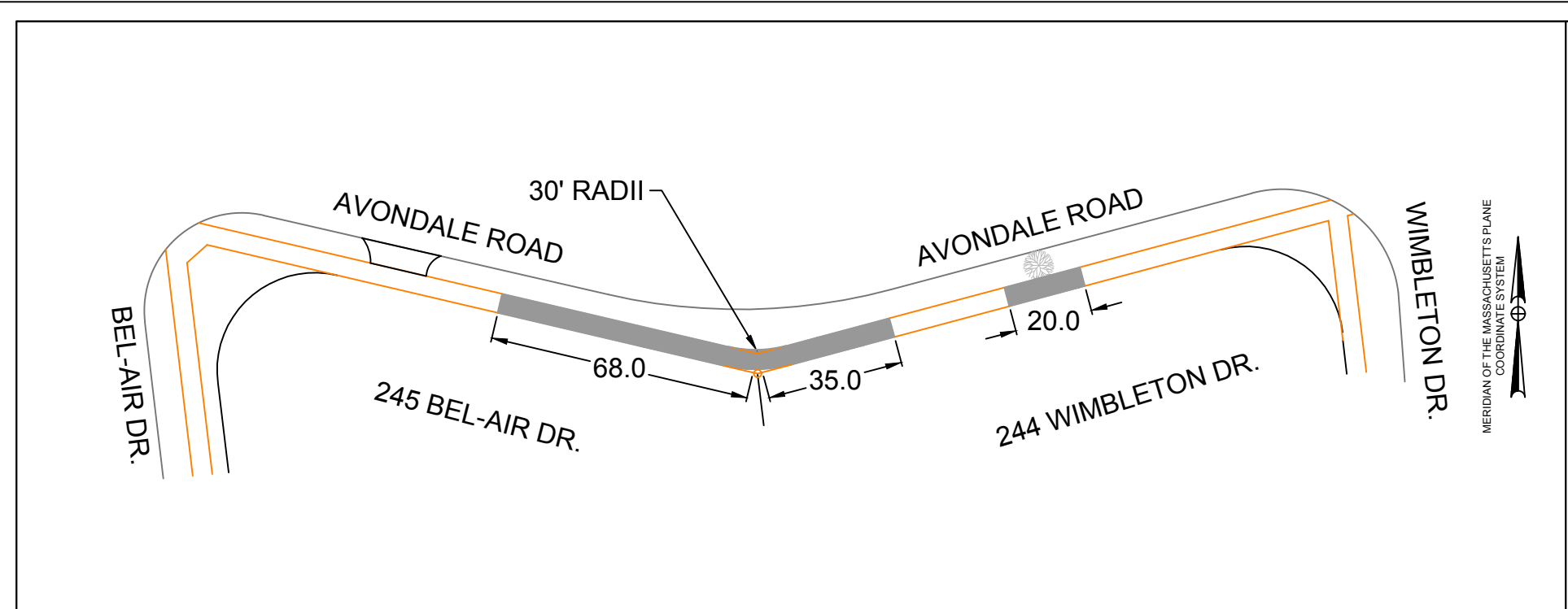

LEGEND

	4" SIDEWALK REMOVE & REPLACE
	6" SIDEWALK REMOVE & REPLACE
	H.M.A. DRIVEWAY APRONS

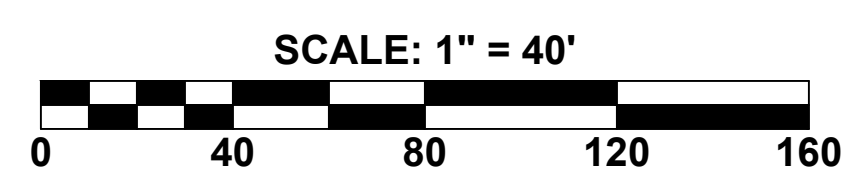

TOWN of LONGMEADOW ENGINEERING DEPARTMENT
 2021 SIDEWALK REPLACEMENT PROJECT

**Miscellaneous Locations
 Sidewalk Replacement
 Longmeadow Ma, 01106**

DATE: April 2021
 2021 Sidewalks Construction Plans.dwg Drawn by: CM Approved by: TK

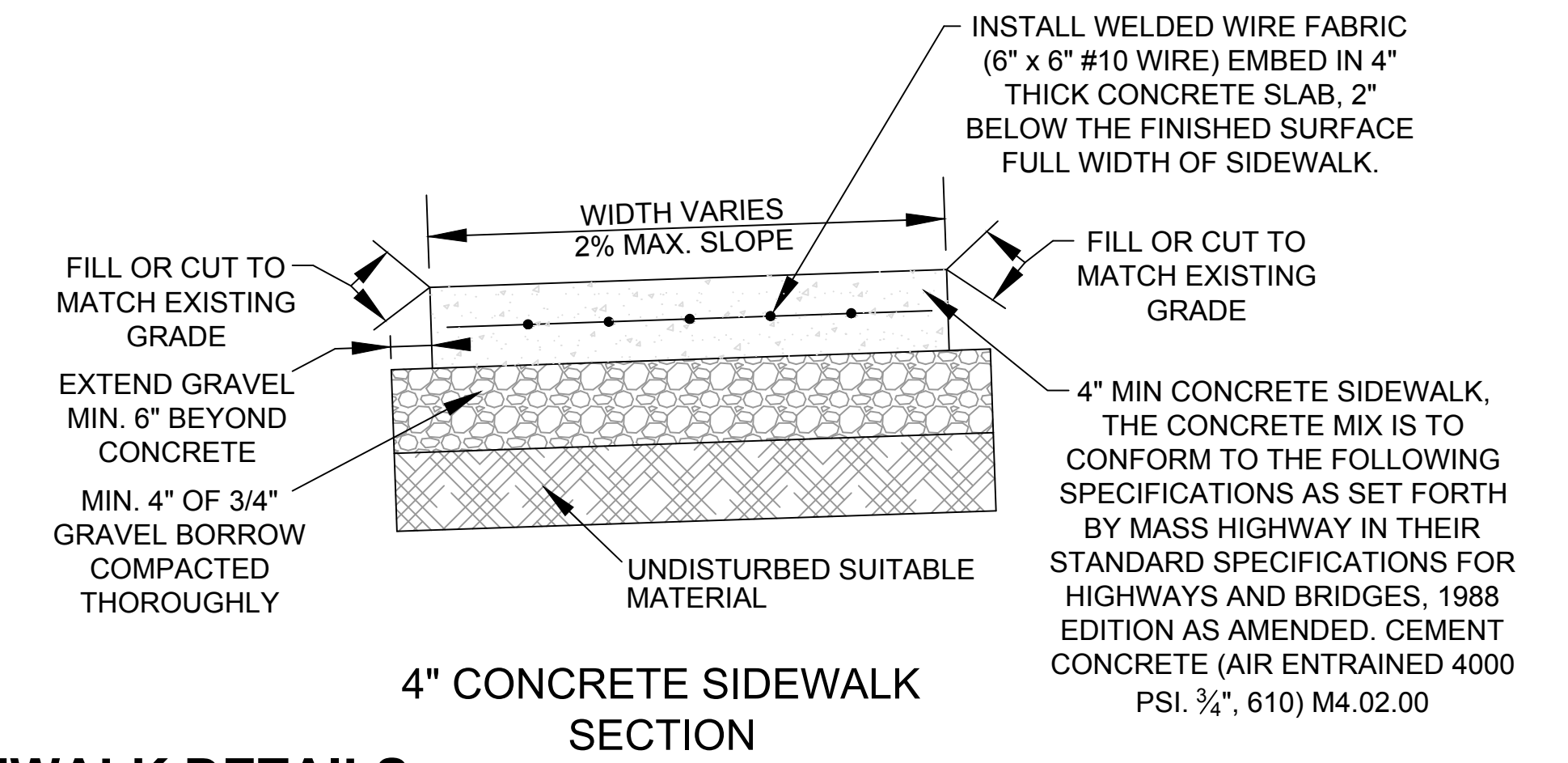
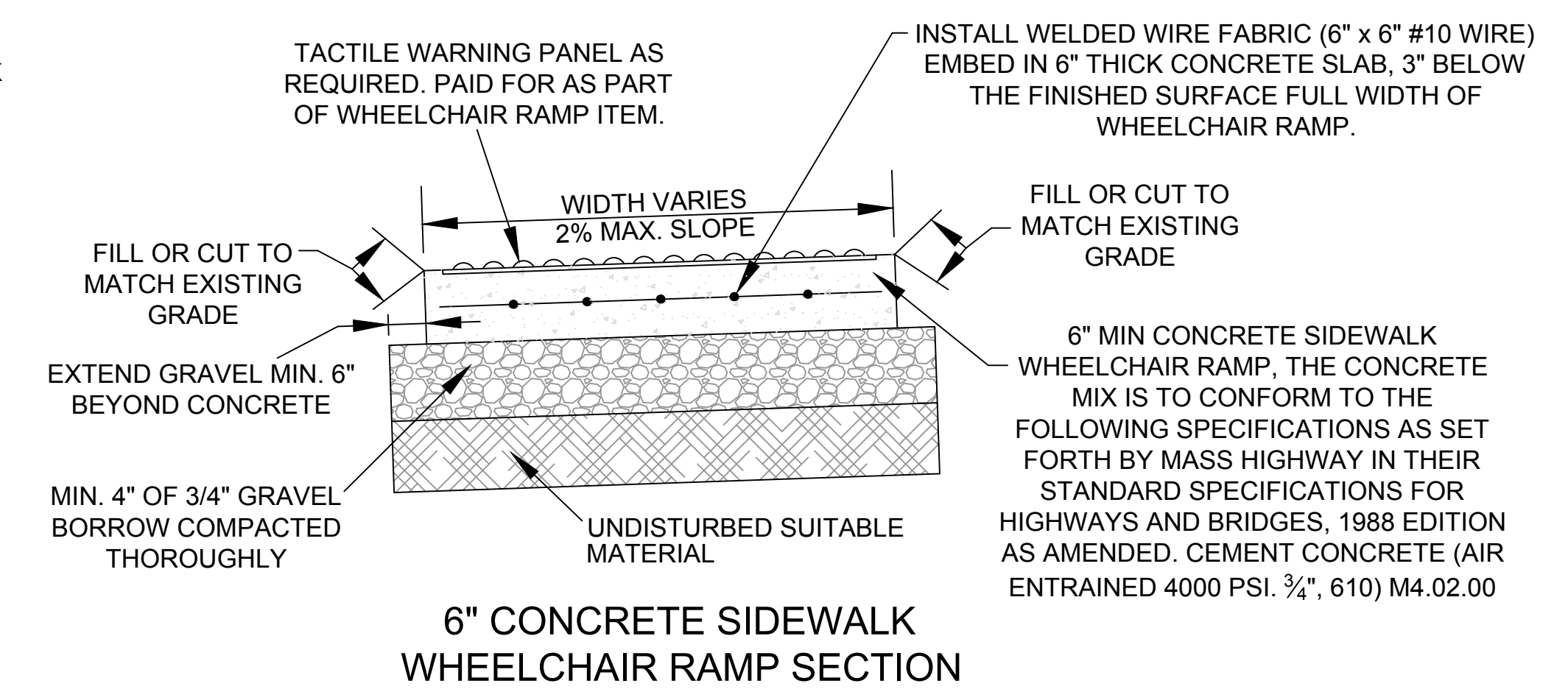
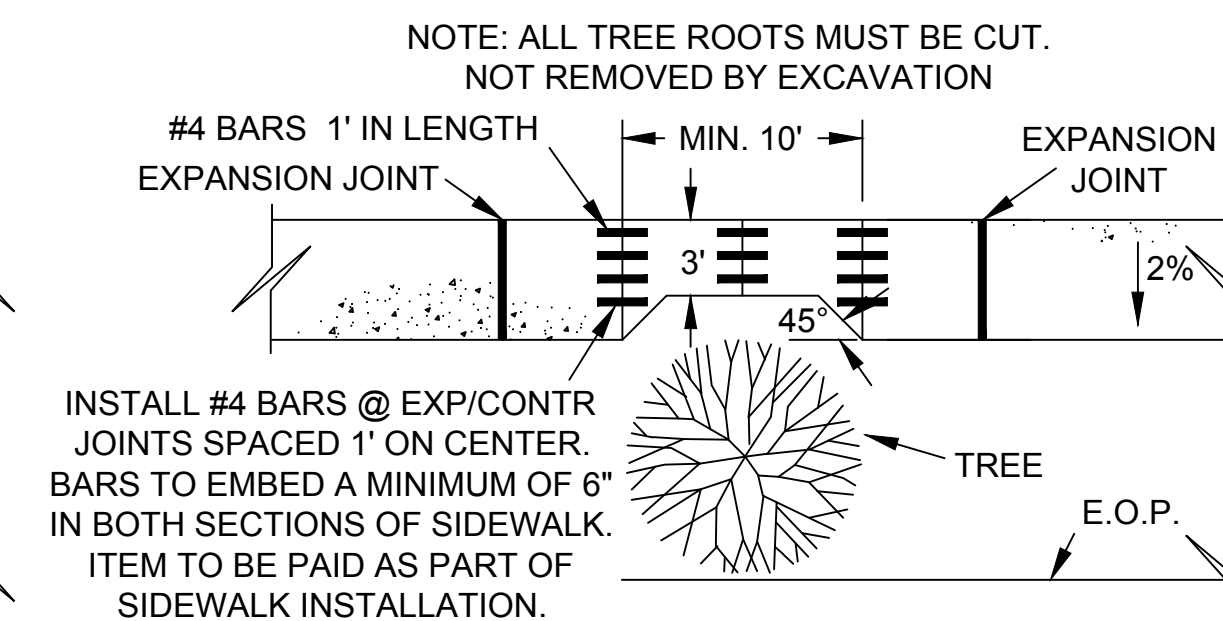
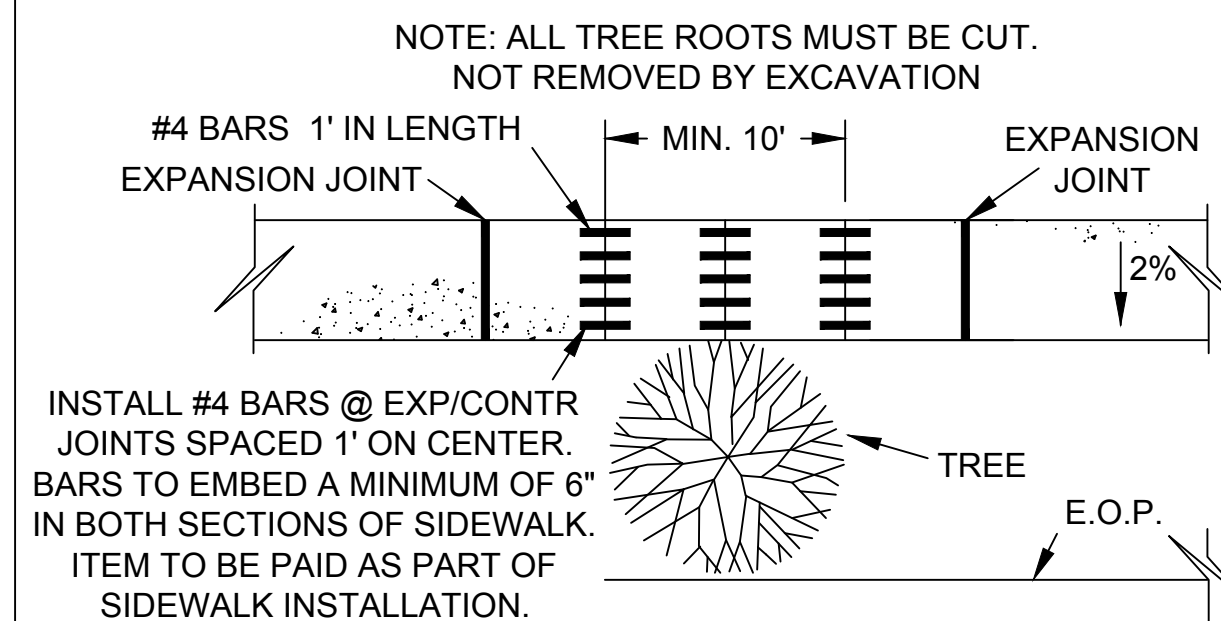
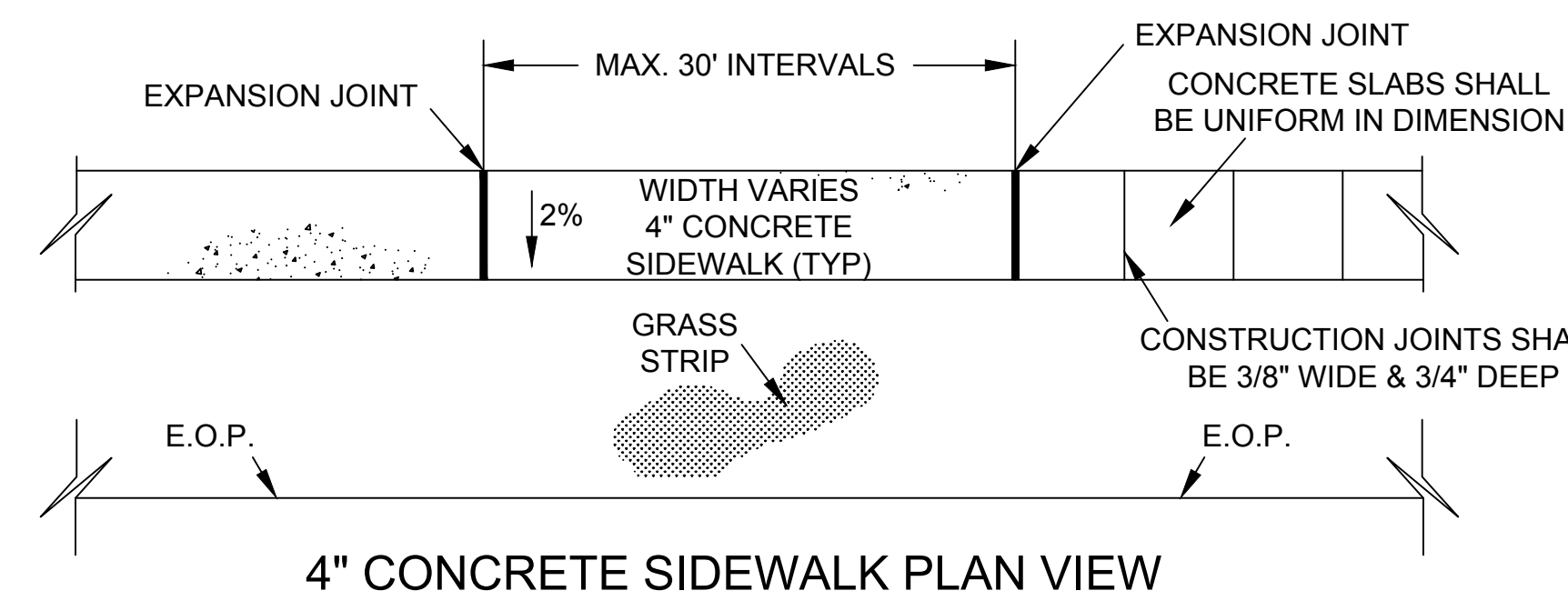
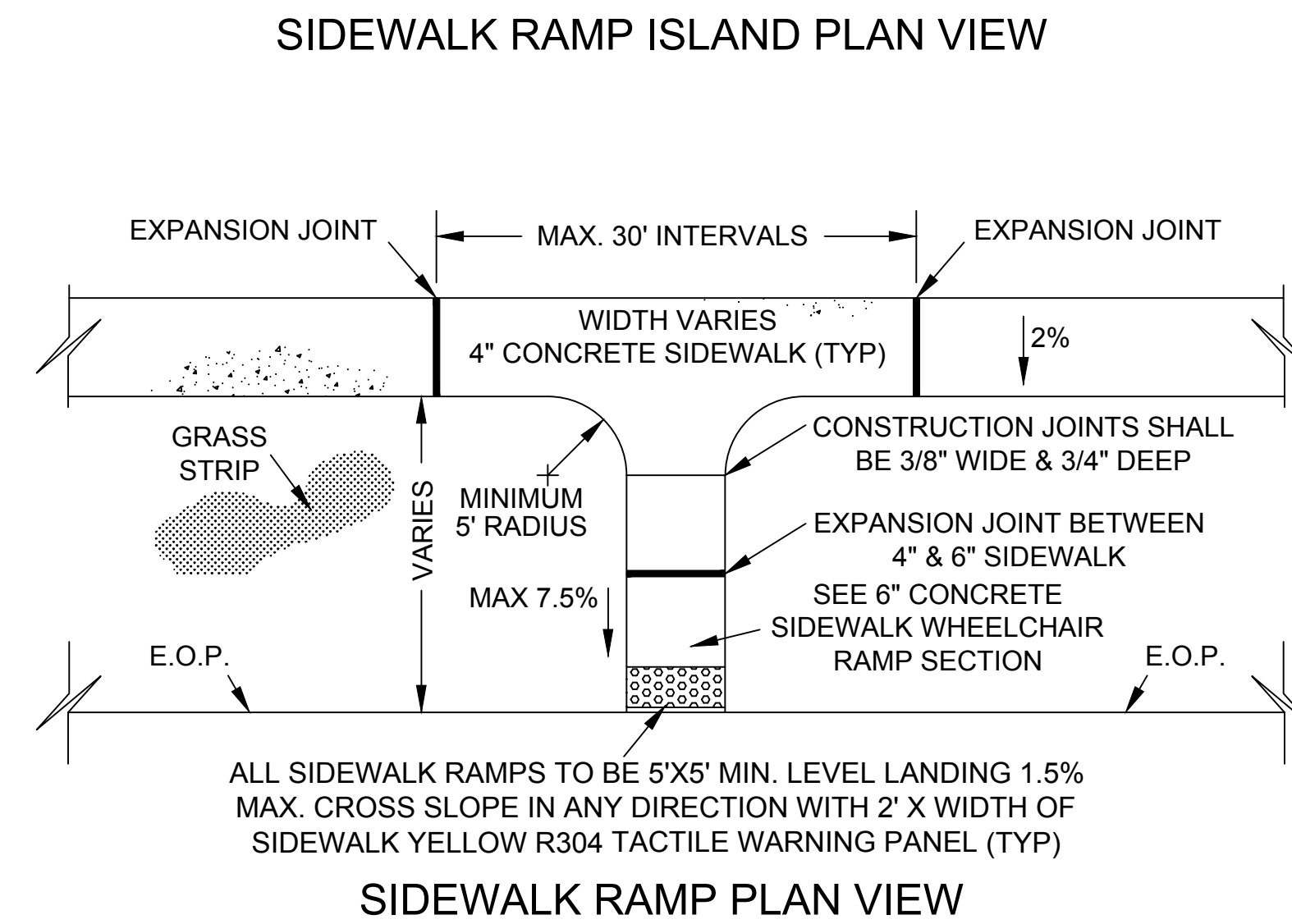
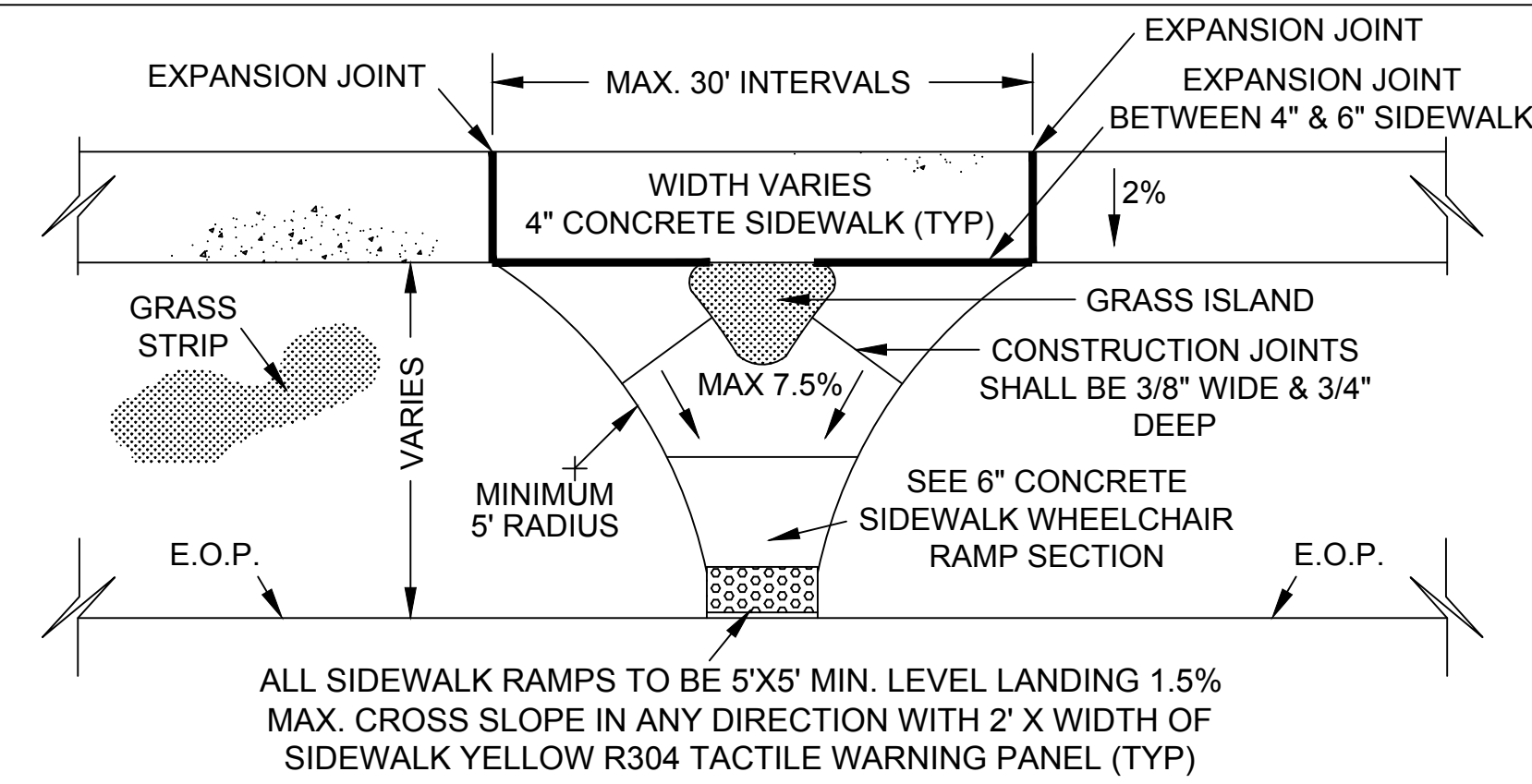
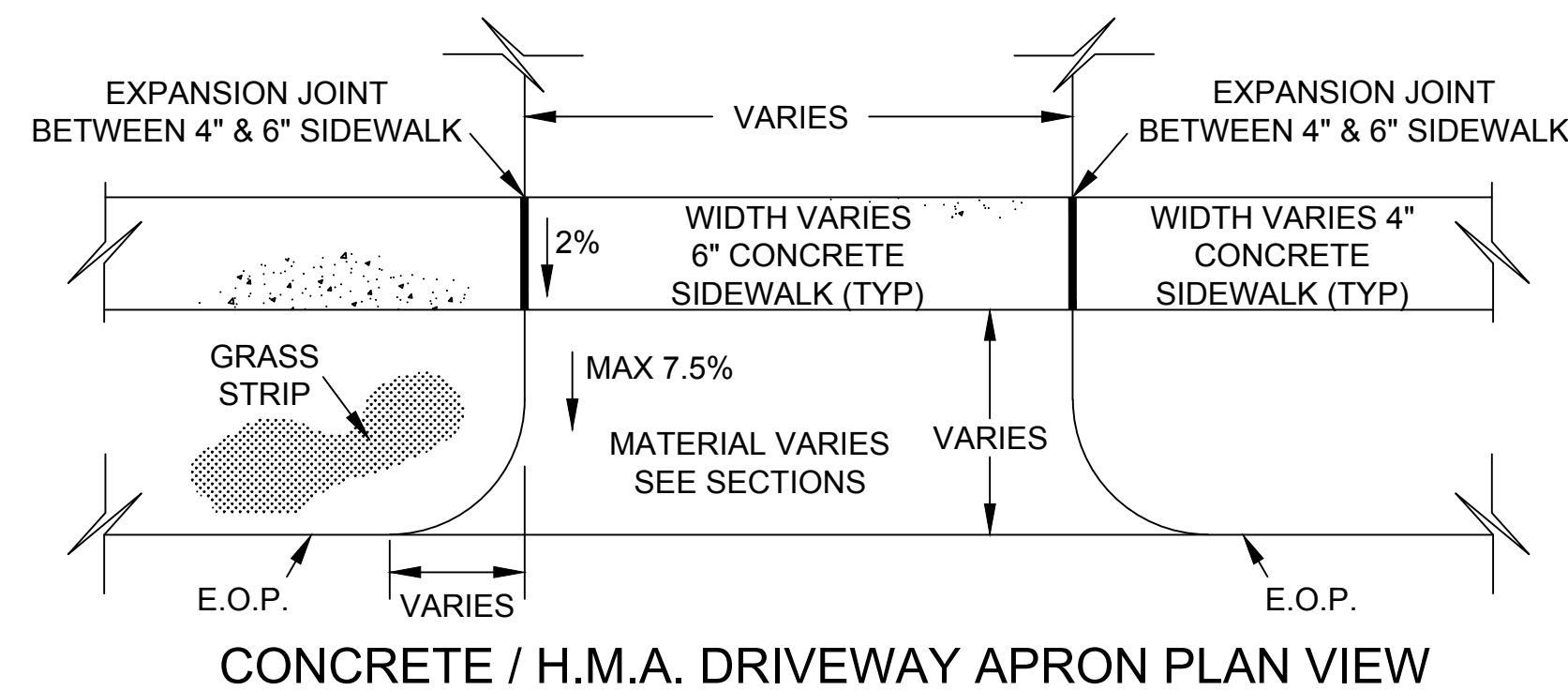
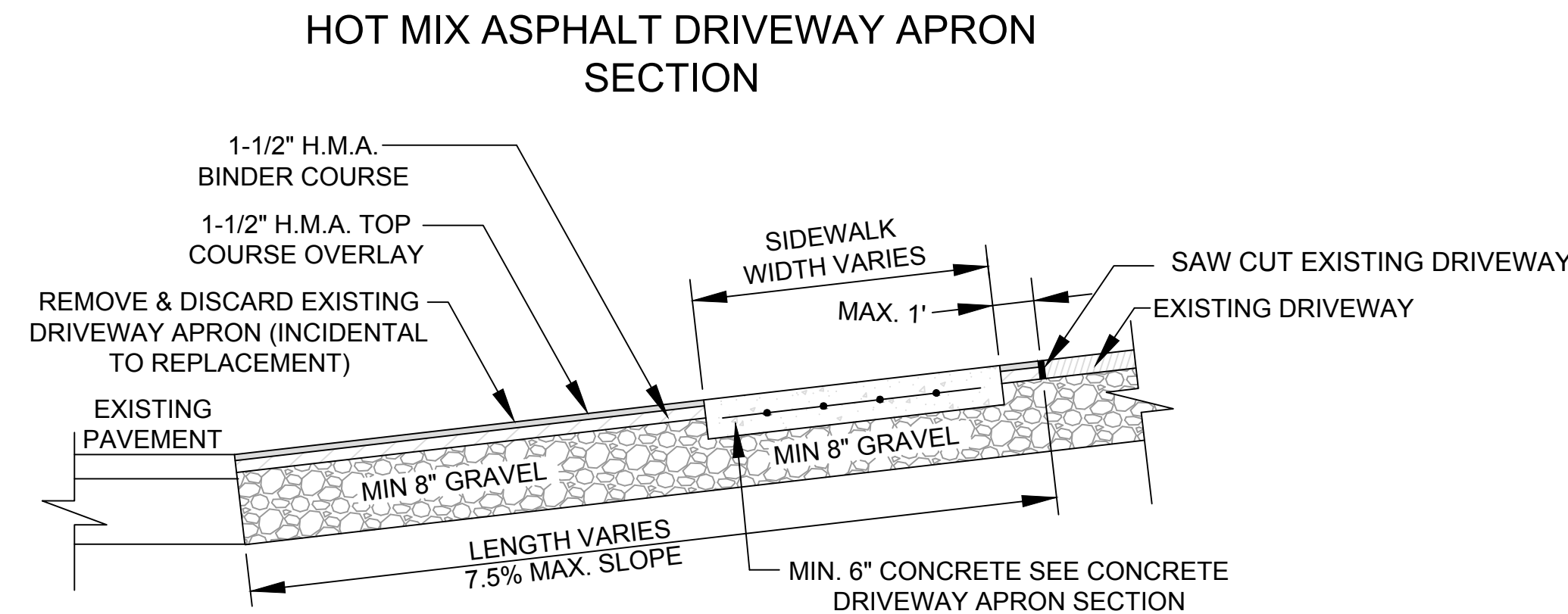
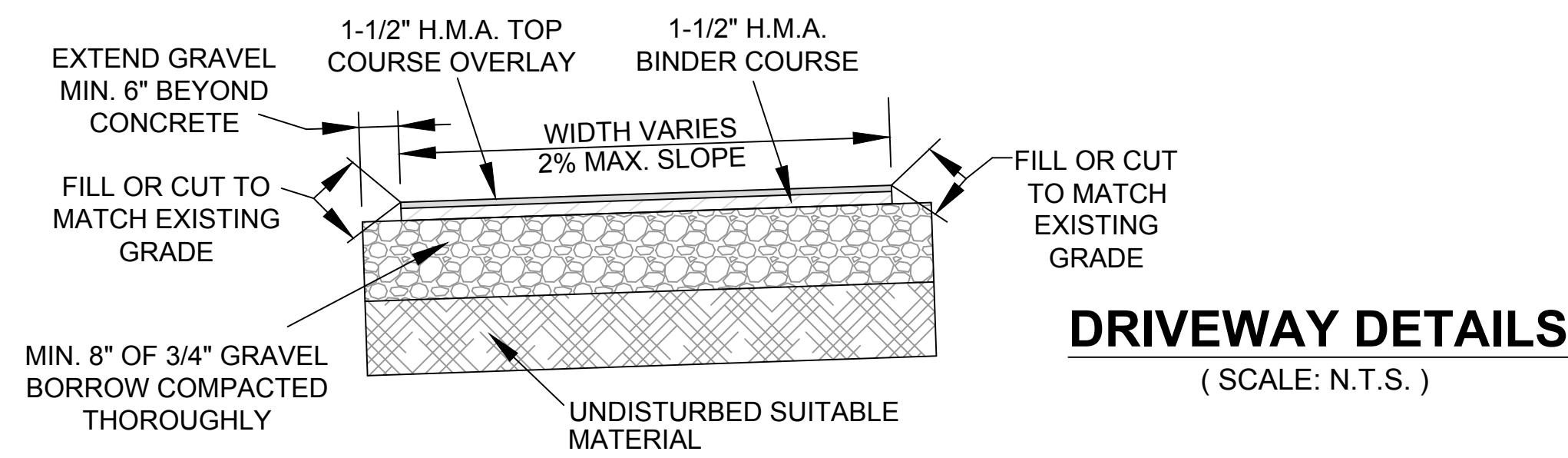
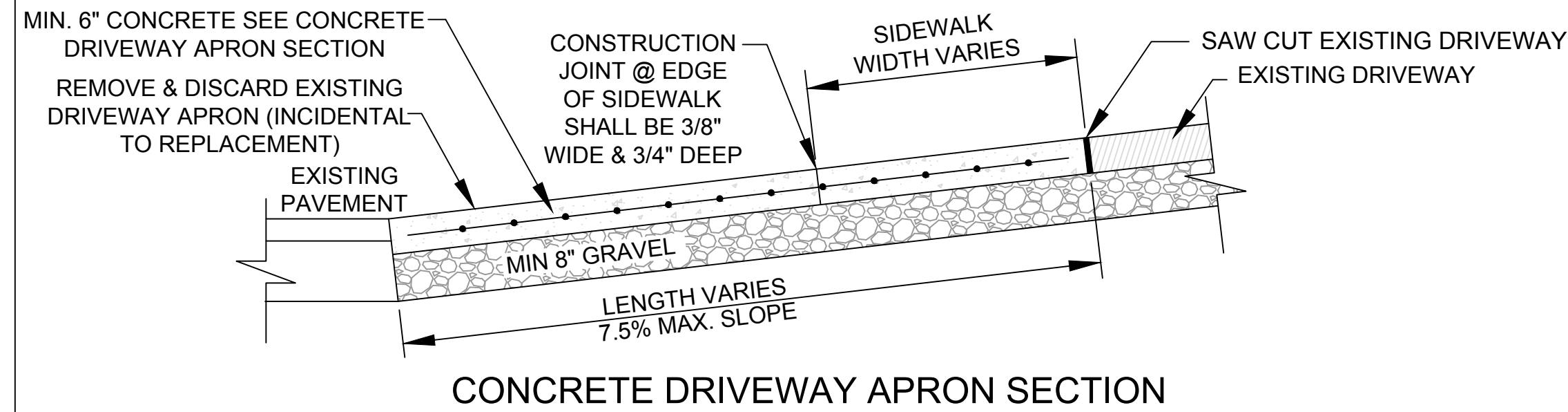
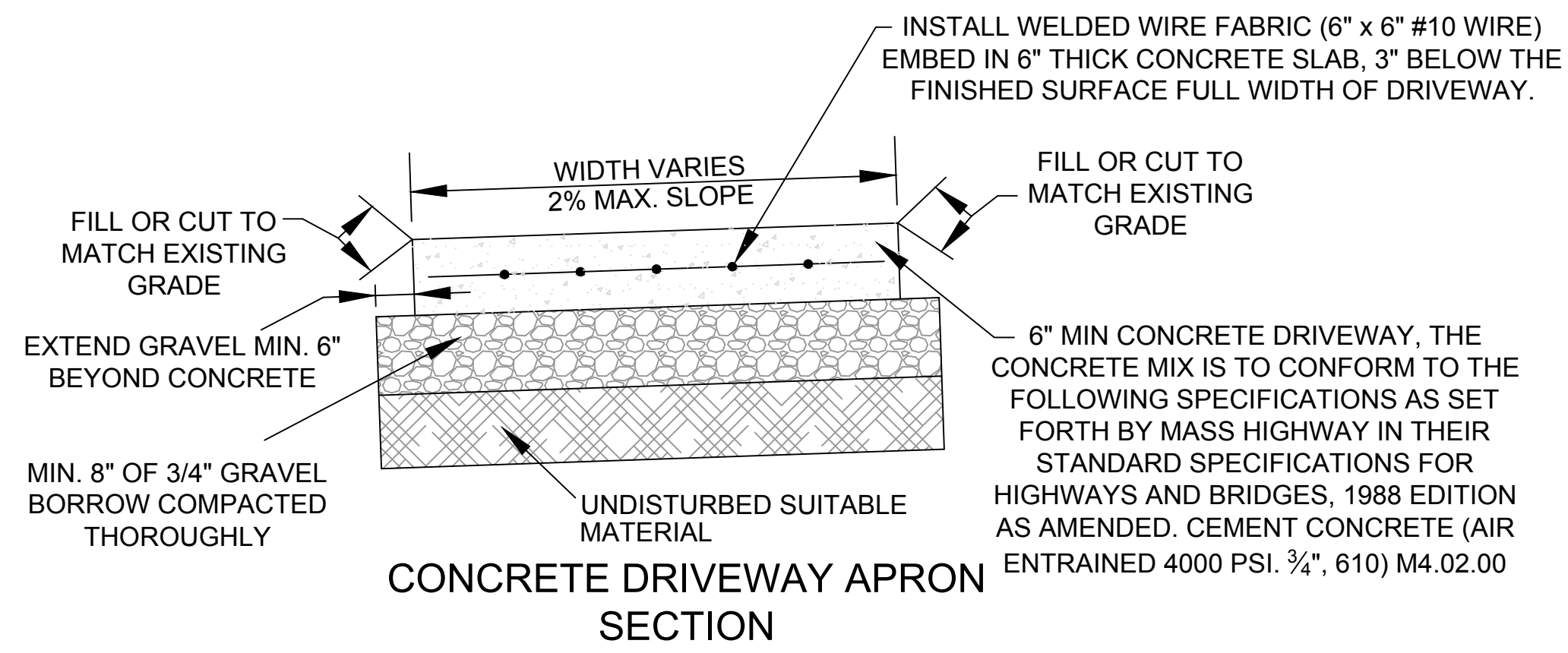

SIDEWALK DETAILS
(SCALE: N.T.S.)

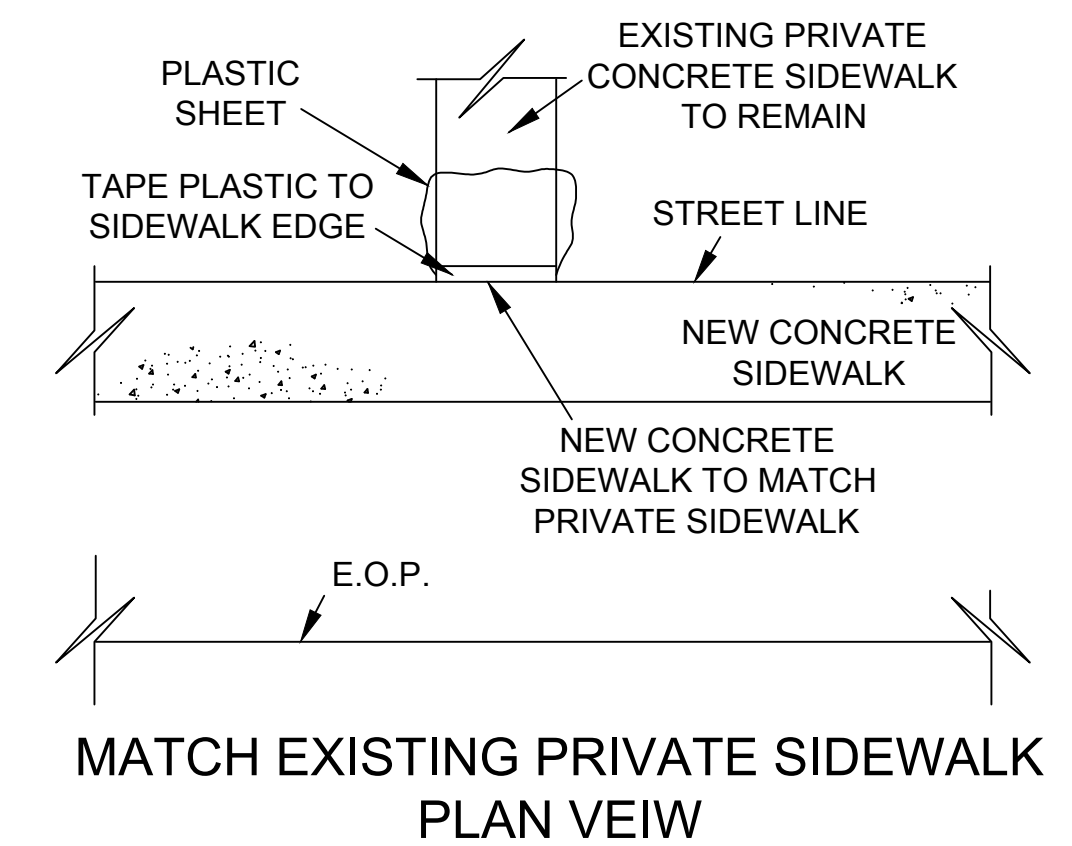

TOWN of LONGMEADOW ENGINEERING DEPARTMENT
2021 SIDEWALK REPLACEMENT PROJECT

Details & Sections
Longmeadow Ma, 01106

SCALE: N.T.S. DATE: April 2021
2021 Sidewalks Construction Plans.dwg Drawn by: CM Approved by: TK